

THE A.W.A. GATEWAY

Volume 1, Number 4, December 2011



IN THIS ISSUE:

Vacuum Tube Chronology
Sparton and Steinite Histories
Troubleshooting a Battery Set
Choosing a Soldering Iron
Managing Your "Junkbox"
Of Interest to Members

Your Entry to the Fascinating World of Vintage Communications

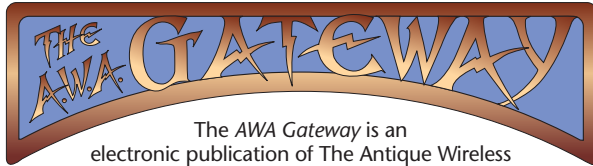

The AWA Gateway is an electronic publication of The Antique Wireless Association, downloadable without charge from the AWA website www.antiquewireless.org, to stimulate interest in vintage communications history, equipment restoration and collecting.

OFFICERS

DirectorTom Peterson, Jr.
Deputy Director.....Robert Hobday
CuratorBruce Roloson
Secretary.....Dr. William Hopkins
Treasurer.....Stan Avery



TRUSTEES

Stanley Avery, WM3D	Richard Neidich
David Bart, KB9YPD	Lauren Peckham
Lynn Bisha, W2BSN	Allan Pellnat, KX2H
Geoffrey Bourne	Thomas Peterson, Jr.
Marc Ellis, N9EWJ	Ronald Roach, W2FUI
Dr. Thomas Ely, W2ODW	Bruce Roloson, W2BDR
Robert Hobday, N2EVG	John Terrey, W5TDQ
Prof. William Hopkins, AA2YV	Ron Walker, WA2TT
David Kaiser	Morgan Wesson
Felicia Kreuzer, KA2GXL	Roy Wildermuth, W2IT
James Kreuzer, N2GHD	

MEMBERSHIP SERVICES COMMITTEE

Chairman.....Richard Neidich
AWA Journal Editor.....Marc Ellis, N9EWJ
Membership DataEd Gable, K2MP*
AWA Review Editor.....Robert Murray*
Conference ChairmanRoy Wildermuth, W3RLW
*Ex Officio Members

WEBSITES

Website: www.antiquewireless.org
Special Convention website: www.awaconference.com
Special Development website: www.antiquewirelessmuseum.com

Antique Wireless Association is an IRS 501(c)3 Charitable Organization

THE AWA GATEWAY STAFF

Editor

Marc F. Ellis N9EWJ
mfellis@alum.mit.edu

Design and Production

Claudia Gray Sweet

Copy Editor

Joseph J. Schroeder, Jr., W9JUV

ABOUT OUR COVER

The scene that is partially revealed behind the gateway is the Marconi transmitter complex at Poldhu, southwest Cornwall, England, that sent the first transatlantic radio signal. The three dots, representing the Morse letter "s," were received by Marconi at St. John's, Newfoundland on December 12, 1901. Shown are two of the four sturdy towers that replaced the two antenna masts used in the original test.

The AWA Gateway cover was created by Will Thomson of Armadillo Arts, Iowa City, Iowa.

The AWA Gateway is published approximately four times a year by The Antique Wireless Association. AWA is a non-profit historical society founded in 1952 and incorporated in the State of New York. Antique Wireless Association is a trademark of the Antique Wireless Association.

AWA is not liable in any way for any buying or selling transaction entered into as a result of the content of this publication. Contents © 2011 Antique Wireless Association; © 2011 Antique Radio Club of America except where otherwise indicated.

Welcome to The AWA Gateway!

3From the Deputy Director

4Reader Stories: Jim Falls, K6FWI

5The Receiving Tube Story

Part 4: Chronology of Vacuum Tube Development

7Company Chronicles

Sparton and Steinite

8Play it Again

Troubleshooting a Simple Battery Set

9About the Antique Wireless Association

10Members' Corner

News of Particular Interest to the AWA Membership

12Clubs That Will Welcome You

13Tips and Tidbits

Choosing a Soldering Iron;

"Junkbox" Management;

Customizing a "No Name" Radio

14Reader Internet Sites

From The Editor

Welcome to the final issue of the first year of *The AWA Gateway*. We of the Gateway staff have enjoyed putting this new publication together for you, and we hope that you are finding it informative, educational and interesting.

The Gateway is free to all—AWA members and non-members alike—and has a triple mission: to encourage interest in vintage communications history and hardware; to provide basic information for those who would like to enter the hobby; and to supplement *The AWA Journal*, our print publication for members, as a source of information about our organization.

So far, the basic hobby information has been provided by your editor, drawing heavily on material in a newsletter he published for newcomers to the hobby over a decade ago. Of course this kind of material doesn't exactly ever go out of date, and I'm pleased that it can be circulated once more to those who find it useful.

However, our vision for *The Gateway* is that it should become an interactive publication reflecting our readers' current interests. During the year to come, we hope that this publication will include articles and comments contributed by the readership.

If you are an interested newcomer to the hobby, write me with your questions and suggestions. We'll not only use them as springboards to make improvements in *Gateway*, but also publish them in a "Letters to the Editor" column where they might stimulate more input from other readers. We also encourage you to learn more about AWA, including *The AWA Journal*, by exploring our website at www.antiquewireless.org.

If you are already well advanced in our hobby, we solicit not only your questions and comments, but also your contribution of articles on topics that would encourage and assist newcomers. If you don't have time for a longer article, you might contribute to our "Reader Stories" column. Just send a few paragraphs detailing what stimulated your interest in radio collecting, history, or restora-



Marconi at his St. Johns receiving station. Courtesy David Read.

tion as well as some of your current activities. Be sure to include a picture or two! Do you already have a web site detailing your interests, collection, etc? Then send us the URL for publication in our "Reader Internet Sites" column.

If you'd like to discuss possible contributions, contact me at mfellis@alum.mit.edu or 847-869-5016. For brief comments tweet to @AWAgateway. I'll be looking forward to hearing from you! — Marc Ellis, N9EWJ

From The Deputy Director

SECURING THE FUTURE OF YOUR COLLECTION

In my last *Gateway* column I discussed some of the varied reasons people collect items of historical significance. And I might add, we often do it just because we enjoy the "hunt" and the thrill of finding that very special piece. In addition to the collecting (accumulating, as my wife calls it), we also enjoy restoration, preservation, research and documentation which are all the ways we turn an artifact into living history.

So, as we age and we are all doing that, we need to think about what might happen to our collections sometime in the future. You may be fortunate to have a spouse or a son or daughter and or a grandson or granddaughter that shares your hobby and will enjoy and preserve your collection. But, unfortunately, most of us are not that blessed.

My advice is to make sure your family is aware of the historical significance, estimated value and how you obtained each artifact in your collection. Too often the family thinks of those treasures in your collection as "dusty old worthless radios and stuff" and unknowingly disposes of your collection without protecting its historical values. Therefore, I also suggest you contact an appropriate museum or another trusted collector to carry on and preserve your wonderful collection. Of course, the AWA would be happy to discuss how we might assist you.

WE ATTEND THE RCofA FORT WORTH MEETING

On November 18th to 20th, fellow AWA Trustee David Bart and I represented the AWA at the Radio Club of America annual meeting and dinner in Fort Worth Texas. For those of you not familiar with the RCofA, it is the world's oldest radio club, having been founded in 1909. Throughout its rich history RCofA members have included most of the innovators, scientists, developers, manufacturers, and visionaries of the communications and entertainment industry including Edwin Armstrong, Lee de Forest, David Sarnoff, Alan DuMont, Alfred Grebe, Jack Poppele, Martin Cooper, and AWA's Bruce Kelley just to name a few.

In 2010, AWA became the proud depository and curator of the RCofA archives containing the 100+ years of communications history. That archive is now located at our Dr. Max Bodmer Media Center.

During the meeting Dave and I were able to renew and establish great friendships. The AWA provided a display of historical interest on the First ARRL Banquet held in 1921 (this is the 90th anniversary) and the infamous ARRL Wouff Hong and Rettsynich "awards."

At Friday's technical meeting, we were astounded by an extremely poised presentation on fractal antennas by high



A portion of the AWA-provided display at Fort Worth—covering the first ARRL banquet, held in 1921.

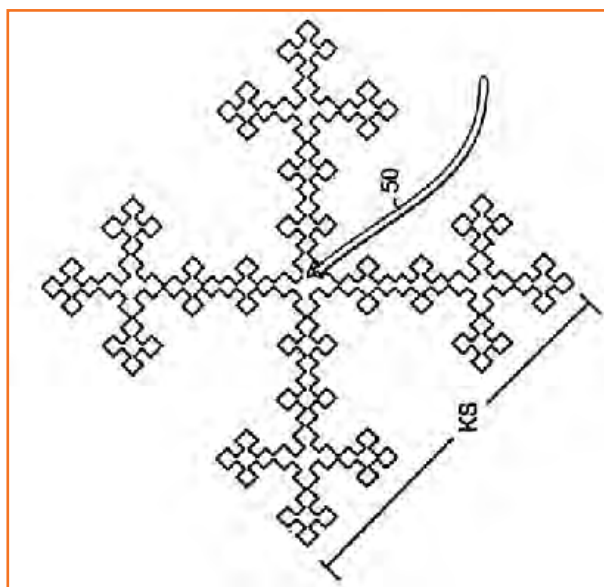

Fractal antenna patent drawing.

school junior Austin Schaller, KD0FAA. Through Austin's program, we learned that a fractal antenna is an antenna that uses a fractal, self-similar design to maximize the length, or increase the perimeter (on inside sections or the outer structure), of material that can receive or transmit electromagnetic radiation within a given total surface area or volume.

Although only 17 years old, Austin prepared and presented a very professional program detailing his development of a computer program to predict the performance of fractal antennas and, using models he constructed, did field tests to verify his computer results.

Austin's grandfather sparked and supported his interest in ham radio as did the RCofA Education Committee lead by Carole Perry. Austin is one amazing young man and I am pleased he is now a new member of the AWA. Watching this poised young man, I was reminded that RCofA, now in its 102nd year, was started by a small group of teens. Our young people can do amazing things if we can stimulate and support them as Austin Schaller's grandfather did.

READER STORIES: JIM FALLS

In this issue, we have another reader story for you. It comes from Jim Falls, K6FWT. In contrast to Don Ignatius, whose story appeared in the last issue, Jim's interests lie more with vintage military and ham gear than with vintage broadcast items. Jim's story follows. Perhaps next time we'll be printing your story! You'll find contact information for me on page 2.—MFE

I've been collecting radios for over 30 years. Early on, I picked up a Hammarlund SP-210-SX at an auction and listened to it for years as a SWL. One night I was tinkering with what I thought was the antenna lead on the back while watching the S-meter. My wife said she heard a strange "squawk" from the back room, and the house lights dimmed for a moment. I awoke on the other side of the room with a burned spot on my finger. Those 300+ volts definitely got my attention. I stored "the hammer," started building crystal sets, and in the process really began to learn how radios worked.

Eventually I was asked to show some of my sets at the local ham club (www.Humboldt-arc.org). They were a hit, and several members began gently urging me to get my Tech License. I passed the exam a few months before 911, and I quickly learned to appreciate the contribution we hams can make when all else fails. I became active in the club (I've been the President twice) and enjoy providing communications assistance during public events.

My appreciation for the solid construction and relative simplicity of World War II military gear led me to become a member of the West Coast Military Radio Collectors Group (www.mrcgwest.org) and I've amassed a fairly large collection of military items. I also have quite a few pieces of vintage ham gear.

My ham shack is a converted gazebo in the back yard, enclosed and insulated with recycled building materials. My workhorse rig is a Swan 350 feeding a dipole through a homebrew tuner. I also run a stock BC-375E w/PE-73 dynamotor on the air weekly and it puts out its rated output of 55W on 75M AM. The rig has good audio and minimal FM as long as I run it strictly "by the book" and don't push it too much.

My latest project is a Hartley oscillator using a pair of parallel 27s that I built for last year's AWA Bruce Kelley Memorial 1929 QSO Party (www.antiqwireless.org/hamevents2010.htm). It puts out a nice, stable 6W and I have enjoyed leisurely, SLOW CW QSOs on 80 up and down the west coast. Nothing beats communicating with someone using a rig you built yourself!

—73 DE Jim K6FWT



Jim's backyard shack, a converted gazebo, has a vintage look in keeping with the equipment within.

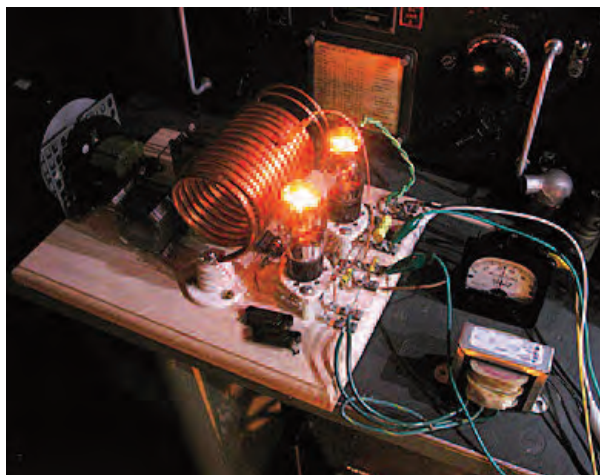

This homebuilt Hartley netted Jim many pleasurable contacts during the Bruce Kelley QSO party.

The Receiving Tube Story

Part 4: Chronology of Vacuum Tube Development

Our discussion of receiving tube development ended with the conclusion of “The Format Wars” in Part 3 of this series. But before leaving the subject, I’d like to give you a chronological listing of the major developments in tube design during the period covered by the series (about 1920 through 1940. Almost all of the “landmarks” summarized here have been discussed in some detail in one of the preceding parts of the series, though some new material has been added.

1920

RCA releases the type UV-200 (detector) and the type UV-201 (amplifier). These were the first receiving tubes produced for the home radio mass market. Their 5-volt filaments were designed for automobile-type storage battery operation.

1922

Type WD-II released by Westinghouse. Its filament operated from a single 1.5-volt dry cell, making it suitable for portable (or at least “transportable”) operation. Its unique base pin design was not compatible with any other type.

1923

RCA releases three new types: the UV-201A (an improved version of the UV-201 requiring only 25% of the filament current); the UV-199 (filament operated by three 1.5-volt dry cells); the WD-12 (a version of the WD-II having a standard UV base.)

Because of the high-efficiency thoriated tungsten filaments in the UV-201A and UV-199 tubes, it became necessary to use a “getter” to remove all traces of oxygen from the bulb. The getter was typically an internal magnesium pellet that was fired off as the bulb was being evacuated.

This consumed the oxygen and also left a silvery deposit on the inside of the glass. An earlier getter compound, used only briefly, left a rainbow-colored



“UV” base had locating/locking pin for bayonet mounting, short contact pins.

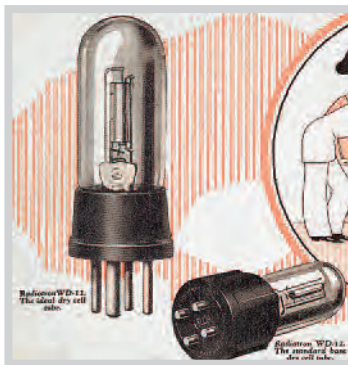

Drawing from RCA ad shows WD-II (upright) and WD-12 tubes. Note fat pin (plate connection) at front of WD-II base.



After 1930, tube bases lost side pin, could no longer be bayonet mounted. “Push-in” installation became the standard.

deposit. Rainbow tubes are prized by collectors.

Westinghouse and RCA agree that Westinghouse broadcast-radio products, including the WD-II and WD-12 tubes, will be sold only under RCA’s (Radiotron) brand name.

1924

The pointed “tip seal” began to disappear from the top of the UV200, UV-201 and UV-201A bulbs, moving to the bottom, where it could be protected inside the base. However, the bulbs retained their original pear shape. The WD-II bulb became narrower in diameter, but retained its tubular shape. Bakelite replaced brass as the base material for all tubes except the WD-12.

1925

The long-pin UX-type base (designed for push-in sockets) replaced the short-pin UV-type base (designed for bayonet-mount sockets). But the horizontal “locating and locking pin” was retained so that the new tubes could still be bayonet-mounted into the older sockets.

The WD-II and WD-12 bulbs lost their pointed tip seals and acquired magnesium getters, making their bulbs silvery inside rather than clear. The WD-12 tubular bulb was reduced in diameter to match the 1924 change in the WD-II bulb, and its brass base was changed to Bakelite.

New tube types introduced included: WX-12 (same as WD-II and WD-12, but with UX-type base); UX-112, 120, 210 (power amplifiers); UX-213 (full-wave rectifier).

1926

New tube types introduced include: UX-200A (improved version of UV-200 having thoriated filament, long-pin base); UX-171 (power amplifier).

1927

New tube types introduced include: UX-222 (battery-filament, tetrode [screen-grid] amplifier); UX-226 and UX-227 (AC filament amplifiers); UX-112A

and UX-171A (improved versions of UX-112 and UX-171 power amplifiers); UX-280 (heavy-duty, full-wave rectifier).

1929

Release of UX-224 (AC-filament tetrode [screen-grid] amplifier).

1930

Horizontal locating and locking pins began to vanish from tube bases, so the new generation of tubes would no longer fit the old UV-style sockets. At the same time, type numbers are simplified by dropping the old prefixes. For example, the UX-201A became the 01A, and the UY-227 became the 27. Release of 24-A (quicker-heating version of the type 24).

1931

Release of the first pentodes: type 33 (battery filament); type 47 (direct heated [no cathode], but suitable for AC operation); type 38 (for auto radios but indirectly heated [cathode-equipped], so suitable for AC operation as well). Release of the 35/51 variable-mu screen grid amplifier.

1932

The pear-shaped bulb used on most tubes up to that time began to disappear, to be replaced by the type "ST" (sometimes known as the "taper-top," "dome-top" or "double-dome" style). Release of the type 39 pentode (RF amplifier, companion to type 38), and other indirectly-heated pentodes including the types 59 and 42 power tubes and the types 57 and 58 IF amplifiers.

1933

"2-digit" tube numbers are exhausted; new "number-and-letter" system, based on tube function and characteristics is introduced. The 6F7 is an early example.

1935

First metal tubes released. First "glass-octal" tubes released.

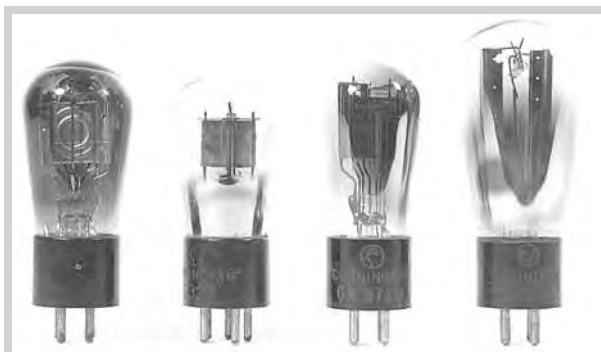

The tubes that made the first true AC sets possible included, from left: UX-226, UY-227, UX-171-A and UX-280.

1936

6L6 beam-power amplifier released.

1938

The first glass tubes with tubular envelopes ("GT" tubes) are released.

1939

First "single-ended" tubes released. First series of "Loktal" tubes introduced by Sylvania.



The "GT"-style glass tubes had tubular envelopes; were much more compact than their "G" equivalents.

1940

First miniature tubes released.

With this "Chronology of Vacuum Tube Development" our Receiving Tube Story series is completed. Watch for a new topic in the next issue!—MFE



The original miniature tubes, designed for use in battery portables, had 1.4-volt filaments. This is the 1R5 pentagrid converter.



The Loktal tube, originated by Sylvania, had a unique locking groove on its locating pin.



As soon as metal tubes were released in 1935, radio manufacturers raced to put them in their sets and hype them in the media.

Company Chronicles

See copyright statement at end of article.



In the year 1922, Atchison, Kansas resident Fred W. Stein formed the Atchison Radio and Electric Company to engage in the sale of galena crystals. The crystals, marketed under the name Steinite, hit the market in 1923 — complete with advertising puffery claiming 1000-mile reception. Mr. Stein, whose formal education had ended with the eighth grade, had been in the electrical contracting business prior to World War I and served in the Navy during that conflict.

Soon after going into the crystal business, Stein progressively expanded his line to include crystal detector assemblies, complete crystal sets, and one-tube radios. These sets were all sold through the mail by means of newspaper advertising.

In mid-1925, the entrepreneur purchased Tri-City Radio Electric Supply Co. (Tresco) which, though foundering, was the possessor of an Armstrong license. Sets manufactured during this period carried the Tri-City name and an Atchison, Kansas address.

1926 saw the introduction of a pioneering AC-operated set utilizing series-string '99 tubes. This popular radio went through three revisions, selling so briskly that the Company opened a Chicago sales office the following year.

Things continued to move quickly for Mr. Stein's little company.

In 1928, an RCA license was acquired with the help—so the story goes—of fire-eating Missouri Senator Jim Reed. Reed is reported to have bearded a reluctant General Sarnoff in the latter's office, refusing to leave until a license was issued.

The license made it possible for Steinite to market, that same year, a state-of-the art AC-operated set (which was priced a couple of dollars less than the competitive Atwater Kent Model 40). Also in 1928, the Steinite company was sold to Chicago capitalists Jacob Abelson and Oscar Gertz.

In October of 1928, the Company purchased control of the Leslie F. Muter Co., a radio parts manufacturer. By early 1929, stepped-up merchandising efforts raised sales to new peaks.

Steinite soon acquired an addition, a plant located in Auburn, Indiana, and built a third one in Fort Wayne. By October of that year, the Company employed almost 1200 workers and was turning out a reported 2,000 sets per day.

However, as with most companies of that era, the Depression eventually took its toll. Steinite was reorganized

at the beginning of 1930 with Jim Tully (formerly of Bremer-Tully) in charge. By April, the Company was in receivership, with debts of \$1.3 million. Magnavox bought the Fort Wayne plant in May; Steinite reorganized again in October to make private-brand radios, lasting another couple of years before going out of business.



The Sparks-Withington company, manufacturers of "Sparton" brand radios, had its beginnings in 1900. At that time General W. R. Withington, head of a large agricultural implement company in Jackson, Michigan, set up sons Philip and Winthrop in business making small steel parts. The two soon hired 27-year-old William Sparks, then a grocery store manager, to be their bookkeeper.

Sparks, who had emigrated from England with his parents some 13 years before, became the company's driving force. Under his leadership, the company became a manufacturer of stamped steel parts, including radiator fans and horns, for the growing automobile industry.

Like many automobile parts manufacturers of the era, the Sparks Withington firm decided to have a crack at radio manufacturing. The first Sparton sets, advertised in 1926, used the Kellogg AC tube in order to avoid paying royalties to RCA. But as insurance against the eventuality that RCA might force Kellogg out of business, the firm soon set up its own tube production factory under the "Cardon" name. Sparton sets sold briskly, but a suit filed by RCA in 1928 forced the company to switch from the TRF circuitry it was using to a non-infringing hookup licensed from the Technidyne Corp. This led to the development of the Equasonne models of mid-1928, for which the company had to design, and manufacture under carefully controlled conditions, a special tube known as the type 484.

Later, after RCA began to sue Sparks-Withington under other patents, the firm did negotiate an agreement with RCA. Now there was no need for the tube manufacturing operation, which was merged into the parent firm in 1930. Unlike most of its competitors, Sparks-Withington was still making a profit in 1930, struggling with red ink, however, through most of the Depression.

The company did survive, though, manufacturing radios and television sets until 1958, when certain of its assets were sold to Magnavox. Sparks Withington (its name changed to the Sparton Corporation in 1956) still exists today (1991), largely in the defense business, and operates out of some of the original factory buildings.

These company biographies, used with permission, were abridged from Alan Douglas's three-volume encyclopedia Radio Manufacturers of the 1920s, published by Sonoran Publishing, 6505 West Frye Rd., Suite 15, Chandler, Arizona 85226, sonoranpublishing.com, and copyrighted 1988, 1989 and 1991 by Alan Douglas.

Play It Again

A No-Nonsense Guide to Vintage Radio Restoration

PART 4—TROUBLESHOOTING A SIMPLE BATTERY SET

Now it's time to get our hands on an actual vintage radio. We'll be discussing the servicing of a simple 1920s "three dialer" battery radio. This type of radio was very common during the decade of the 1920s and is distinguished by its long, coffin-shaped case and three prominent tuning dials. We'll use the 1925 (late) Atwater Kent Model 20C as our example. These sets are popular with collectors because they are attractive, well designed and simple to service. Parts are easy to find.

Troubleshooting a radio is best done by following a definite stepwise procedure. This is mine:

1. KEEP WRITTEN RECORDS

Records are important to help you remember what you did and to "brief" anyone who may acquire the set later.

2. CLEAN AND INSPECT CHASSIS

Remove the chassis from the cabinet and clean it. I use a 1" paint brush to dislodge dust and dirt and remove it with a vacuum cleaner hose held nearby. Don't apply the hose directly to the set; you may disturb components! Inspect the chassis for obvious problems such as loose or broken connections. Check for corrosion of tube sockets and filament rheostats. Check the tuning capacitors to see if they turn freely.

3. REPAIR ANY PROBLEMS FOUND

Solder broken or suspicious joints and repair or replace broken wires. See that screwed or bolted connections are free of corrosion and tight. Clean socket contacts with a small bronze gun-cleaning brush. Burnish the resistance wire and slider of the filament rheostat(s) with 400 grit emery paper. If necessary, lubricate the bearings of the tuning capacitors and filament rheostat(s) with a drop of

20W motor oil. Rotate the shafts to work the oil in until they turn smoothly.

4. TEST THE TUBES

Follow the instructions for your particular tester and be sure to check for shorts and gas. Clean corrosion off the tube pins with steel wool. However, do not use steel wool anywhere near the chassis!

5. CHECK ELECTRONIC COMPONENTS

This step is practical only on simple sets with few electronic components, like this one. The diagram is shown in Fig. 1. It is a TRF receiver using grid damping resistors to stabilize the RF amplifiers. The troubleshooting procedure works backwards. We start at the speaker (if the set has one) and work towards the antenna. This is the best way to troubleshoot complex receivers and find out what does work in an otherwise dead set. It is less important in this simple set, but we will follow the procedure anyway.

Use your ohmmeter to check the primary and secondary of each audio transformer. You should get a reading of a few hundred to a few thousand ohms. You may have to do some wire tracing to identify the leads. In AK sets, the audio units are potted in round metal cans.

Check the resistors next. They are a common problem in 1920s sets. R3, the grid leak, is a glass unit resembling a fuse held in clips. It frequently increases in value or opens up with age. It should be in the range of 2-5M Ω (original was 2M Ω .) If it yours is open or out of range, solder a replacement in parallel with it under the chassis out of sight. Leave the original in place for appearances.

R1, R2 and R4 are wirewound units. The resistance wire is often broken. R4 is a tapped resistor of 500 Ω total. AK seemed to think performance was better if the detector grid

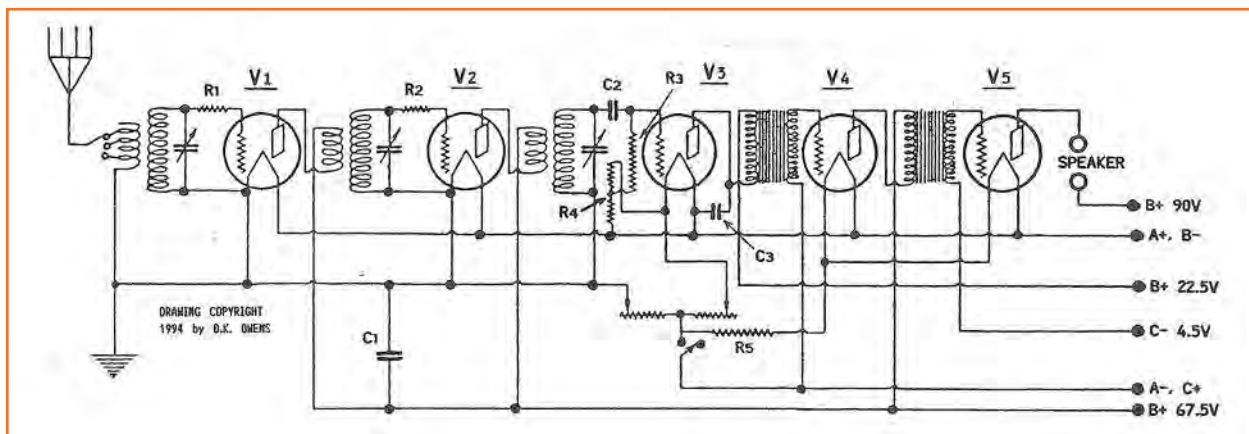

Fig. 1. Schematic of the Atwater Kent Model 20C.

was returned to a point between A+ and A- rather than to A+ as was common. The upper portion of R4 was 300Ω and the lower was 200Ω. If yours is bad, use small carbon resistors of 220Ω and 330Ω wired in under the chassis.

R1 and R2, the grid damping resistors, are 800Ω each. I rewind mine with resistance wire obtained from Antique Electronic Supply. They are mounted on the backs of the tuning capacitors where they show, so carbon replacements would look bad. R5 is a fixed wire resistor to drop the voltage to the AF amplifier filaments. I have never seen a bad one.

C2 and C3 are mica capacitors which almost never go

bad. C1 is a 0.5μF paper capacitor potted in a metal case. It bypasses the RF amplifier plate supply for increased stability. It should have infinite resistance, but usually doesn't. If it measures less than 1MΩ, I replace it. Heat the original in a disposable aluminum pie plate on the stove at low heat until the wax softens enough to pull the old capacitor out of the metal case. Solder one lead of a 0.47μF/400V "Mylar" capacitor to the case and the other lead to the original wire. Stuff some paper in to take up most of the empty space, arrange the capacitor in the case and top it off with some of the potting wax to preserve the original appearance.

Next time we will finish our repairs and power up.

ABOUT THE ANTIQUE WIRELESS ASSOCIATION

The Antique Wireless Association is an organization of over 2100 international members linked by a common interest in the history of electrical and electronic communications. AWA members come from all walks of life and our ranks include teenagers, octogenarians, and beyond in both directions. At one of our meets, you might find yourself shaking hands with a retired broadcast executive or military electronics specialist, an engineer in a high-tech electronics firm, or an eager young person looking for advice on restoring his or her first radio.

The organization was started in 1952 by Bruce Kelley, George Batterson, and Linc Cundall—amateur radio operators and radio collectors from upstate New York. Their initial goal was to establish a museum where they could collect and preserve early wireless and radio equipment and historical information before it was lost to future generations. Decades later, their legacy continues to motivate our members.

Some of us are most interested in the technical background behind the epoch-making discoveries that now make it as easy to communicate across the globe as around the corner. Others enjoy the romance surrounding the men and institutions that put these discoveries to work: the maritime radio operators who averted disasters with their alert ears and quick thinking; the short-wave stations that radiated glimpses of exotic cultures and mindsets; the giant radio networks that delivered unparalleled entertainment and timely news to our homes while hawking toothpaste, cigarettes and soap flakes.

Though AWA members share this common interest, which many can trace back to early childhood, they express it in different ways. Some of us collect radio-related literature and manuals. Others collect and restore hardware: Morse keys and sounders, battery radios of the 1920s, telephones, advertising signs, cathedral and console radios—you name it! Collections can become very specialized, restricted to such things as radio components crafted of shiny Bakelite and gleaming brass or perhaps the fragile and intricate vacuum tubes that made the communications miracles possible.

Among our members are meticulous craftsmen who enjoy replicating vintage receivers and/or transmitters.

Those who are licensed amateurs frequently operate such equipment in special communications events sponsored by the AWA.

In addition to the commitment to the preservation of historical artifacts and background materials at the Museum, AWA also publishes *The AWA Journal* and *The AWA Review*. The *Journal* is a quarterly publication that gives our multi-talented members an outlet to share their historical research, equipment restorations, troubleshooting and servicing tips and other information of common interest. *The AWA Review*, which also publishes member contributions, contains more extensive and scholarly papers. It is published once a year.

The AWA Gateway is the latest addition to the AWA family of publications. It's delivered electronically and free of charge—downloadable from our web site www.antiquewireless.org.

Our content is targeted at those who may not be familiar with the AWA and who perhaps are just becoming interested in the history, collecting or restoration of vintage communications gear. For that reason, our technical articles are more basic than those in our other publications and our articles about AWA generally do not assume knowledge that that only those familiar with our organization might have.

The AWA also sponsors a four day annual convention in August featuring technical presentations and forums, a large auction, an awards banquet, an equipment and artifact competition, a book sale, and an active flea market. The convention affords attendees plenty of time to renew and make friendships, time to engage in long conversations on collection, preservation and all other aspects of the hobby.

The AWA is chartered as a non-profit organization in New York State, an IRS 501(c)(3) tax-exempt corporation, and is a member of the American Association of Museums. To learn more about AWA or to join our organization, visit the AWA website at www.antiquewireless.org.

DONATING ARTIFACTS TO THE AWA

You may have artifacts that you are interested in donating to the AWA. We would be pleased to discuss any possible donation. Please call us at (585) 257-5119.

Members' Corner

News of Particular Interest to the AWA Membership

MEMBER SERVICES COMMITTEE REPORT

By Richard Neidich, Chairman

Board Meeting Highlights

On Sunday, November 7, 2011, the AWA Board of Trustees held their fall meeting at the AWA Media Center following the Annual Membership Meeting. The Trustees received presentations from each of the activity chairmen, reviewed last year's fiscal results and reviewed the Fiscal Year 2012 Budget as major items.

Museum Curator Bruce Roloson reported on a major donation (over 2000 items) to the Museum's collection as well as on the initial planning for the work necessary to renovate Building 1 (the former Peddler's Village Antique Mall) to house the new museum facility.

Membership Services Chairman Richard Neidich pre-



The fall AWA Board of Trustees Meeting in full swing at the Max Bodmer Media Center.



Museum Curator Bruce Roloson presents his report at the Trustees Meeting. From left: Bob Hobday, Deputy Director; Tom Peterson, Director; Bruce Roloson; Ron Roach, Operations Manager.

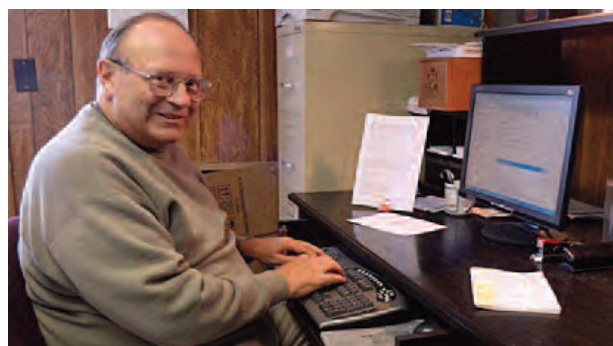

Curator Emeritus Ed Gable updating the AWA Membership database.

sented a review of the Fiscal 2011 activities for the Committee's efforts. These included actions to contain costs while maintaining previous membership service levels to the membership. No increase in dues will be required due to an increase of 114 new members and continued attention to cost containment for the Membership Services activities.

These actions included the use of non-profit organization postage for *The AWA Journal* and a separate first class proxy mailing for the Annual Membership Meeting. Additionally, efforts are continuing to update our e-mail contact information, allowing use of e-mail to communicate with members instead of a first class mailing. During the next quarter, we will begin e-mailing members to alert them to the release of each new issue of *The AWA Gateway*.

Since *The AWA Gateway* can contain color pictures at no additional cost, it is planned to use that publication to document to members the build-out of the new museum facilities as it progresses.

It was noted during the report that every AWA member should seek out and encourage likely candidates for AWA membership. This would broaden interest in AWA as well as increase our dues revenue.

Our membership records are maintained and regularly updated by Ed Gable, Museum Curator Emeritus. Any member who has not yet provided Ed with a valid e-mail address may contact him via a special e-mail account provided for the purpose: AWAProfileInput@gmail.com. Beginning in December, routine e-mailings will be made to all registered members.

Besides notices and links to the latest *AWA Gateway*, we plan to e-mail membership renewal notices, as well as other items of interest, to members with addresses on file. E-mailing the renewal notices could initially save over \$500.00 annually. —Richard Neidich, Chairman

MUSEUM OPERATIONS REPORT

By Ron Roach, Operations Manager

Planning the New Museum

After considering proposals from a number of contractors for controlling water incursion at the projected museum as well as providing efficient heating and cooling of the facility, a recommendation was presented to Director Tom Peterson at the November 6th AWA Board meeting.

It involves the installation of a new floor a foot higher in elevation than the present one and enclosed by an interior concrete berm. Our Tuesday volunteer group has begun to remove the contents of the future museum to facilitate the floor installation. We have leased sufficient storage off-campus in East Bloomfield to temporarily house the removed materials and artifacts.

Approval for installing a water line to our Gauss Road facility (Building 3) was received at the East Bloomfield Town Board Meeting in late October. Once trenching is completed, additional communication links between The Media center (Building 2) and Building 3 may be installed along with the water line.

Finally, a team of technicians from the GEVA Theater

Center, a professional theater facility of Rochester, NY, visited Building 1 with Bob Hobday, Ron Roach and the AWA contractor to assess the sound and lighting demands of the educational auditorium planned for the new museum. They provided valuable expertise and suggested economical equipment sources.

MUSEUM OUTREACH

On Friday evening, November 11th, an extended tour of the new campus and the current (Academy) Museum was provided for the Rochester VHF Group by Duncan Brown and Ron Roach. It was the first time some of the dozen visitors had seen the AWA facilities.

Lynn Bisha and Ron Roach conducted a tour of the Academy Museum for a Cub Scout group from East Bloomfield on Saturday, November 19th. Twenty-seven Cub Scouts and parents were introduced to the museum displays during the ninety minute tour.

The AWA supported a recent performance of the Penfield Players by providing a period Marconi radio that was used prominently during the production. In addition Lynn Bisha, Deputy Curator, selected several period radios for display during the run of the play. Stan Avery provided a generous supply of sample AWA *Journals* and Ron Roach provided a storyboard featuring the new museum along with Academy Museum brochures. Karen Tuccio, director of the play, prefaced each performance with a brief history of our organization, encouraging the audience to examine the AWA displays during the intermission.

FROM THE CURATOR

By Bruce Roloson

A Stunning Gift

As the Curator of the AWA Museum, I try to help families of members who have passed on deal with collections that are sometimes quite extensive. In this case the member, whose family wishes to remain anonymous, was one I have known for over 30 years. He had turned an old carriage house into a really fine radio museum and the entire contents have been donated to AWA.

As you can see in the photo, he had acquired an extraordinary variety of artifacts, from World War I Wireless to broadcast radios and advertising signs of all eras. When you walk in and turn on the lights the place just comes alive with the glow of neon.



Building 1 on the new AWA campus, formerly an antique mall, will become the new AWA museum.



Cub Scouts and parents on their November 19th tour of the original AWA museum in the Bloomfield Academy building.



Just a sample of the extraordinary collection recently donated to the AWA museum.

When Deputy Director Bob Hobday and I went to see it for the first time we just looked at the collection and said "It's as big as our Museum!" These donations will double the display area planned for the new museum. The AWA crews have been cataloging, photographing and packing the collection since June. During the months to come we will highlight some of the pieces and tell more of the story in *The AWA Gateway* and *The AWA Journal*.

RADIO DAZE DISCOUNT FOR AWA MEMBERS

Radio Daze, a premier source of parts and supplies for radio restoration, now offers a special discount for AWA members. The discount is a generous 8% off of catalogue prices, and shipping on domestic orders is free (by ground service of Radio Daze's Choice) for orders of at least \$50.00. Orders under \$50.00 will still receive the discount, but a flat rate of \$5.00 will be charged for shipping.

International orders also qualify for the discount, and shipping will be at a flat rate of \$15.00. For orders that would ordinarily ship for less than \$15.00, there will be a flat charge of \$5.00. Expedited shipping, if requested, will be charged at normal rates.

Radio Daze will check the membership status of each AWA customer for the first order placed in each calendar year, keeping the status on file for the balance of the year.

To shop on line or request a catalogue, go to www.radiodaze.com



Clubs That Will Welcome You

- The Antique Radio Club of Illinois (ARCI)—Meets bi-monthly. Meets generally held at the American Legion Hall, Carol Stream IL but meets in June in conjunction with the 6-Meter Club of Illinois at the DuPage County Fairgrounds and once per year for Radiofest at the Willowbrook Illinois Holiday Inn. Check website for schedules, details and maps.) Contacts: President, Olin Schuler oshuler@comcast.net; Club Public Contact, Art Bilski, 630-739-1060, clubinfo@antique-radios.org. Website www.antique-radios.org.
- Antique Radio Collectors of Ohio—meets first Tuesday of each month at 2929 Hazelwood Ave., Dayton, OH (4 blocks east of Shroyer Rd. off Dorothy Lane) at 7 p.m. Also annual swap meet and show. Membership: \$10.00 per year. For more info, contact Karl Koogler: mail to above address; phone (937) 294-8960; e-mail KARLKRAD@GEMAIR.COM.
- California Historical Radio Society—For info on current meetings, call the CHRS hotline: (415) 821-9800.
- CARS, the Cincinnati Antique Radio Society—Meets on the third Wednesday of each month at Gray's History of Wireless Museum, which is part of The National Voice of America Museum of Broadcasting, Inc., located in a building that is now on the National Historic Register at 8070 Tylersville Road, Westchester, Ohio. 45069. For more information contact Bob Sands at (513) 858-1755.
- Carolinas Chapter of the AWA—Hosts four "mini-swap-meets" each year (in January, May, July and October) plus an annual conference, "Spring Meet in the Carolinas," on the 4th weekend in March. Executive committee meets approximately quarterly. For more info, visit the web site at CC-AWA.ORG or contact Ron Lawrence, W4RON, Chapter President, P.O. Box 3015, Matthews, NC 28106-3015; phone (704) 289-1166; e-mail W4RON@carolina.rr.com.
- Central Ohio Antique Radio Assn.—Meets at 7:30 p.m., third Wednesday of each month at Devry Institute of Technology, 1350 Alum Creek Rd., Columbus. (1-70 Exit 103B.) Contact: Barry Gould (614) 777-8534.
- Delaware Valley Historic Radio Club—Meeting and auction begins 7:30 p.m. on the second Tuesday of each month. Location: Telford Community Center on Hamlin Ave. in Telford, PA. Annual dues: \$15.00, which includes a subscription to the club's monthly newsletter *The Oscillator*. For more info contact Delaware Valley Historic Radio Club, P.O. Box 5053, New Britain, PA 18901. Phone (215) 345-4248.
- Houston Vintage Radio Association (HVRA) meets the fourth Saturday (January thru October) at Bayland Park 6400 Bissonnet, 9 a.m. in SW Houston. Each meeting includes an auction and program. Annual two day convention held in February includes three auctions, old equipment contest, technical talks, swap meet, and awards banquet. One day MEGA auctions held in the spring and fall. A newsletter, *The Grid Leak*, is published bi-monthly. Event postings, announcements, photos and other features are available on HVRA web site: www.hvra.org. Membership is \$20/yr. Address: HVRA, P.O. Box 31276, Houston TX 77231-1276 or call Bill Werzner, 713-721-2242; email: werz1943@gmail.com
- Hudson Valley Antique Radio & Phono Society—Meets third Thursday of month, 7 p.m. Meeting, swap meet, and membership info: Peter DeAngelo, President, HARPS, 25 Co. Rt. 51, Campbell Hall, NY 10916. (914) 496-5130.
- Indiana Historical Radio Society—Meets quarterly in Feb., May, Aug. and Oct. Flea market, old equipment contest and auction at all events. *The IHRS Bulletin* has been published quarterly since 1971. For meet details and information about the club and our Indiana Historic Radio Museum in Ligonier, IN. see our website at www.indianahistoricalradio.org, contact Herman Gross, W9ITT, at 1705 Gordon Dr., Kokomo, IN 46902-5977 (765) 459-8308, or email w9itt@sbcglobal.net.
- London Vintage Radio Club—This Ontario, Canada club meets in London on the first Saturday of January, March, May, June and November. Annual flea market held in Guelph, Ontario in September in conjunction with the Toronto club. Contact: Lloyd Swackhammer, VE3IIA, RR#2, Alma, Ontario, Canada N0B1A0. (519) 638-2827. E-mail contact is Nathan Luo at lvrcreditor@yahoo.com.
- Mid-Atlantic Antique Radio Club (MAARC)—Meets monthly, usually on the third Sunday of the month at the Davidsonville Family Recreation Center in Davidsonville, MD. (But meets once or twice a year in Northern Virginia—check website for schedules, details and maps.) Contacts: President, Steve Hansman, 855 Arundel Drive, Arnold, MD 21012, (410) 974-0561, email: shans01a@comcast.net; Membership Chair, Geoff Shearer, (703) 818-2686, email: gshearer2@verizon.net. Website www.maarc.org
- New Jersey Antique Radio Club—Meets second Friday each month, 7:30 p.m. Holds three annual swap meets. Visit the website, www.njarc.org or contact Phil Vourtsis, 13 Cornell Pl., Manalapan, NJ 07726, (732) 446-2427, pvourtsis@optonline.net.
- Northland Antique Radio Club (Minneapolis/St. Paul)—hosts four events with swap meets each year (in February, May, September and November) including an annual conference, "Radio Daze," for two days in mid-May. Annual dues are \$12.00, which includes a subscription to the club's quarterly newsletter. For more info, visit our web site at www.geocities.com/northland_geo/; contact Ed Ripley at (651) 457-0085; or write NARC, P.O. Box 18362, Minneapolis, MN 55418.
- Northwest Vintage Radio Society—meets the second Saturday of each month at Abernethy Grange Hall, 15745 S. Harley Ave. Oregon City, OR. Meeting starts at 10:00 a.m. Membership \$25.00 per year. Guests welcome at all meetings and functions except board meetings. Spring show, the second Sat. in May. For more information, contact Mike McCrow 503-730-4639; e-mail: tranny53@comcast.net.
- Oklahoma Vintage Radio Collectors—Meets second Saturday of each month, (except for April, October, and December), at Hometown Buffet, 3900 NW 63rd St., Oklahoma City, OK. Visitors welcome. Dinner/Socializing, 6 p.m., meeting, 7 p.m. Swap meets on second Saturday in April and October at 8 a.m., Midwest City Community Center, 100 N. Midwest Blvd., Midwest City, OK. Membership \$15/year including monthly *Broadcast News*. Info: contact

Jim Collings at (405) 755-4139 or jrcradio@cox.net. Website: www.okvrc.org.

- Ottawa Vintage Radio Club—Meets monthly (except June and July) in the Conference Room, Ottawa Citizen, 1101 Baxter Rd., Ottawa, Ontario, Canada. Contact: Lea Barker at (613) 829-1804 or check www.ovrc.org. Membership: \$10 Canadian/yr.

- The Pittsburgh Antique Radio Society welcomes visitors to our Saturday flea markets, contests and clinics held at least four times yearly. A fall auction is included in September and our annual luncheon program is on the first Saturday in December. An annual Tri-State Radio Fest is held in April. Our journal, *The Pittsburgh Oscillator*, is mailed quarterly. For more information visit us at <http://www.pittantiqueradios.org>, email President Chris Wells at radioactive55man@comcast.net, or phone Treasurer Tom Dixon at 412-343-5326.

- Society for Preservation of Antique Radio Knowledge (SPARK)—Meets monthly at Donato's Pizzeria, 7912 Paragon Rd., Centerville, OH. Annual swap meet. Membership, \$18/year. Write SPARK Inc., P.O. Box 292111, Kettering, OH 45429; e-mail sparkinc@juno.com or call John Pansing at (937) 299-9570.

- Texas Antique Radio Club—Meets alternate months in Kyle and Shertz, TX. Contact: Doug Wright, 625 Rolling Hills Dr., Canyon Lake, TX 78133. e-mail dwjw@gvtc.com; website www.gvtc.com/~edengel/TARC.htm

- Vintage Radio and Phonograph Society (VRPS) meets monthly on the third Saturday. Located in the Dallas, Fort Worth Metroplex, our current activities are annual convention, auctions, swap meets, repair training sessions and monthly programs. For details visit our website www.vrps.org, or by contacting VRPS President Jim Sargent at (817) 573-3546 or bsargent@swbell.net.

TIPS AND TIDBITS

CHOOSING A SOLDERING IRON

You may have just started working with antique radios, but it won't be long before you'll need a soldering iron—if only for replacing bad line cords. This month, we'll talk about the different types of irons, and let's start with a word of caution: never purchase a soldering iron if replacement tips for it are not sold at the same store. The tips need to be changed regularly; you should buy a couple of extras when purchasing the iron itself.

The first iron I'll mention is the "instant heat" trigger-operated gun. These are high-wattage devices; they are not recommended for printed circuits because they will quickly burn the circuit traces off the board. The guns reach operating temperature in just a few seconds, but they also cool quickly. So each time you pick up the gun to use it, you'll have to wait for warm-up.

Solder guns are large and heavy; they will tire your wrist during long periods of extended use. Further, most won't handle really heavy jobs such as soldering a large ground strap to a chassis. Yet they are certainly handy for jobs requiring only occasional soldering. Because they cool off rapidly between uses, they're not as much of a workbench hazard as more conventional irons.

"Pencil" type irons can be obtained with automatic temperature control. Typically, these can be adjusted up to 40 watts for heavier work and down to 15 watts for delicate printed circuit jobs. Single-temperature pencil irons are commonly found as 30-watt models.

While good for general radio work, they don't provide enough heat for some of the heavier connections found in tube-type gear. A 40-watt unit is better. I also keep an older 15-watt iron around for use on integrated circuits and for other sensitive work.

Most pencil-type units can be fitted with different styles of tips.

A chisel tip heats most connections faster than a

pointed one. But the more slender pointed tip is very handy when working in tight spaces, as when making connections to tube socket pins.

Another type of iron, now seldom used, is a classic from the 1940s and 1950s. It's the old 80-watt American Beauty (or equivalent). A foot or so long and equipped with a patterned asbestos cord, it is easy to spot at flea markets. Such units are also available new, with non-asbestos cord, but at high cost. If you ever have to solder or unsolder connections to a heavy metal chassis, this is the only iron that will do the job.

Finally, there are a few cordless rechargeable models available.

These are low-wattage units, generally most useful for work with modern semiconductor circuits. They are very light weight, and work much like the solder gun—requiring only a few seconds' warmup prior to use.

The automatic temperature controlled irons are the most expensive; next are guns and rechargeable types. Lowest are the single wattage pencil types—though even these can cost up to forty dollars for a professional or production model. Pencil irons can also be obtained just a few dollars, but remember, you get what you pay for!

If you plan to purchase a single iron to begin working on antique radios, I'd recommend a good-quality 40-watt pencil type with an assortment of tips. Later, as opportunity permits and needs dictate, you can expand your collection of soldering irons.

CUSTOMIZE THAT "HOUSE BRAND" RADIO!

During the 1930s and 1940s, many "house brand" radios were made for sale by drug and department stores and through ads in radio magazines and catalogues. Such radios frequently carried no brand name or manufacturer's identification. If you have one

by Dick Mackiewicz

©1995 *The Radio Collector*

of these, you might like to consider customizing it with your own name.

You might remove the dial scale and make a substitute one using a color copier. Your name can then be added using transfer letters.

Or you might make a copy of your name (reproduced via transfer letters or a good computer printer) on clear Mylar stock. The result can then be positioned over the original dial scale, making it unnecessary to remove it. Your name could also be emblazoned on the cabinet using transfer letters of appropriate color. Mask the radio and spray a protective coat or two of Krylon over the letters (unless you'd like to remove them at some future time).

With the modified radio to use as a prop, you can regale your friends with stories about how your family was involved in the early radio business!

JUNK BOX MANAGEMENT

Quite often, in articles dealing with radio restoration, repair or construction, the term "junk box" will appear. An article may state that most of the specified parts can be obtained from the reader's "junk box." The beginning collector may not have a good conception of what a junk box really is.

This term was originally coined by radio-oriented people, probably no later than 1920. The junk box does not really contain junk. True junk goes out with the trash. The radio collector's junk box is actually composed of an assortment of good, useable parts salvaged from non-restorable radio and electronic units.

Let me cite an example: you find a 5-tube chassis, no cabinet, no speaker, no model identification. What do you do with this?

Certainly you should consider restoration as a first option. If the chassis is in good condition, save it, research it and attempt to identify it. If this fails determine if it's worth building a homebrew cabinet for the chassis.

If not, then consider scrapping the chassis. There are some exceptions. I never scrap a chrome-plated chassis, or one with ten or more tubes, or one with four or less tubes. These are fairly unusual and should be kept intact.

Upon scrapping a set, you'll want to save all the knobs, escutcheons, dials, dial plastic or glass and good tubes. By all means save smaller items such as dial pointers, tube shields, decorative screws, shaft couplings and any unusual hardware.

Save all good transformers. Before removing one from the set, note how it was used in the circuit. Is it an IF or RF transformer; a power or audio transformer, etc. Label the transformer with black marker on masking tape. If dealing with a power transformer, mark it with the tube complement of the set. This will help you deduce voltage and current ratings when you are ready to use the unit. Be sure to mark the 115-volt input leads so you'll know where to power up the transformer to test the other windings.

If an audio transformer, note whether it is an inter-stage or output unit and whether it was used in a single-ended or push-pull circuit.

Handy labels for identifying transformer leads can be sourced by Googling "Brady Labels." These are available with a variety of characters, numbers and symbols. Use the labels to mark the leads before you remove them from the chassis. For example, mark both primary wires with the letter "P," rectifier filament leads with "RF," etc.

These labels will last forever, and are not easily torn off. Believe me, there is nothing worse than a whole box of used transformers with no identification! Once the transformer is disconnected and removed from the set, a simple ohmmeter check will ascertain of the windings are good.

This is the first of a series of articles on salvaging parts from unrestorable sets and building up your personal "junk box." More to follow!

READER INTERNET SITES

In the April issue of *The AWA Journal*, we mentioned an idea proposed by reader Steven Johannessen. He felt that *Gateway* readers might find it interesting and stimulating to look at collections our readers might have posted on line. We agreed and solicited URLs. We received and included three of them last time. Here they are again along with some additions received since then. Four readers have responded so far. Additions to the list are always welcome!

Allie Lingo (radiodoc@windstream.net) sent two:
Radios: <http://www.radioatticarchives.com/contributor.htm?code=499>
Test Equipment: <http://www.oldtestequipmentarchives.com/contributor.htm?code=26>

Mike Adams (mike.adams@sjsu.edu) has recently redesigned his Lee de Forest website. Look it over at www.leedeforest.org.

Ron Lawrence sent several URLs featuring his collections and interests:
Radio Heaven Page
<http://radioheaven.homestead.com/menu.htm>

Clough-Brengle test equipment page
<http://cloughbrengle.homestead.com/>
Civilian Conservation Corp. page
<http://radioheaven.homestead.com/CCCradio.html>
Ron's YouTube channel—with video tours of his collections
<http://www.youtube.com/user/w4ron>

The Tube Collector's Association Tube Photo Gallery
<http://radioheaven.homestead.com/TCA.html>

Don Ignatius Collection
www.home.earthlink.net/~dmign/index.htm